

**LSA 47.2**

**Low Voltage Alternator - 4 pole**

365 to 600 kVA - 50 Hz / 456 to 750 kVA - 60 Hz  
Electrical and mechanical data

**LEROY-SOMER**<sup>™</sup>

***Nidec***  
All for dreams

## The best of performance

Nidec Leroy-Somer LSA 47.2 alternator has been designed to offer you the best power generation performances. With its meticulous design and optimized architecture, the LSA 47.2 strikes the perfect balance between compactness, reliability, performance and longevity.

Whatever your application, the LSA 47.2 will meet your needs and will adapt to all situations.

## Standards

Nidec Leroy-Somer LSA 47.2 alternator meets all key international standards and regulations, including IEC 60034, NEMA MG 1.32-33, ISO 8528-3, CSA C22.2 n°100-14 and UL 1446 (UL 1004 on request). Also compliant with IEC 61000-6-2, IEC 61000-6-3, IEC 61000-6-4, VDE 0875G, VDE 0875N and EN 55011, group 1 class A for European zone.

Nidec Leroy-Somer LSA 47.2 alternator can be integrated in EC marked generator set, and bears EC, EAC and CMIM markings. It is designed, manufactured and marketed in an ISO 9001 and ISO 14001 quality assurance environment.

## Electrical characteristics and performances

- Class H insulation
- 2/3 pitch winding, standard 12-wire (6) reconnectable (the LSA 47.2 L9 is available in two versions: 6-wire and 12-wire)
- Voltage range:
  - 50 Hz: 220V - 240V and 380V - 415V (440V)
  - 60 Hz: 208V - 240V and 380V - 480V
- High efficiency and motor starting capacity
- Other voltages are possible with optional adapted windings:
  - 50 Hz: 440V (no. 7), 500V (no. 9), 550V (no. 22 or 23), 600V (no. 23), 690V (no. 52)
  - 60 Hz: 380V and 416V (no. 8), 600V (no. 9), 690V (no. 22 or 23)

## Excitation and regulation system

Excitation system				Regulation options		
AVR	SHUNT	AREP (option)	PMG (option)	C.T. Current transformer for paralleling	Mains paralleling	Remote voltage potentiometer
R250	Standard					√
D350	Option	Standard	Standard	√*		√
D550	Option	Option	Option	√*	√	√

\*: only with AREP or PMG

3-phase sensing is included as a standard with digital regulators.

## Protection system and options

- The LSA 47.2 is IP 23
- Complete winding protection for clean environments with relative humidity ≤ 95 %, including indoor marine environments
- Options:
  - Filters on air inlet: derating 5%
  - Filters on air inlet and air outlet (IP 44): derating 10%
  - Reinforced winding protections for harsh environments and relative humidity greater than 95%
  - Space heater
  - Thermal protection for stator windings and shields

## Mechanical construction

- Compact and rigid assembly to better withstand generator vibrations
- Steel frame
- Cast iron flanges and shields
- Two-bearing and single-bearing versions designed to be suitable for engines on the market
- Half-key balancing
- Greased for life bearings, regreasable bearings (optional)
- Standard direction of rotation: clockwise when looking at the drive end view (for anti-clockwise, derate the machine by 5%)

## Terminal box design

- Easy access to the voltage regulator and to the connections
- Possible inclusion of accessories for paralleling, protection and measurement
- 9-way terminal block for voltage reconnection

# LSA 47.2 - 365 to 600 kVA - 50 Hz / 456 to 750 kVA - 60 Hz

## General characteristics

Insulation class	H	Excitation system	SHUNT (12 wire)	AREP / PMG
Winding pitch	2/3 (wind.6 - 12-wire / wind.6S - 6-wire)	AVR type	R250	D350
Number of wires	12 / 6	Voltage regulation (*)	± 0.5%	± 0.25%
Protection	IP 23	Short-circuit current	-	300% (3 IN) : 10s
Altitude	≤ 1000 m	Total Harmonic distortion THD (**)	no load < 1.5% - on load < 2%	
Overspeed	2250 R.P.M.	Waveform: NEMA = TIF (**)	< 50	
Air flow	0.9 m³/s (50 Hz) / 1.1 m³/s (60 Hz)			

(\*) Steady state (\*\*) Total harmonic distortion between phases, no-load or on-load (non-distorting)

## Ratings 50 Hz - 1500 R.P.M.

kVA / kW - P.F. = 0.8													
Duty/T°C	Continuous duty/40°C			Continuous duty/40°C			Stand-by/40°C			Stand-by/27°C			
Class/T°K	H/125°K			F/105°K			H/150°K			H/163°K			
Phase	3 ph.			3 ph.			3 ph.			3 ph.			
Y	380V	<b>400V</b>	415V	380V	<b>400V</b>	415V	380V	<b>400V</b>	415V	380V	<b>400V</b>	415V	
Δ	220V	<b>230V</b>	240V	220V	<b>230V</b>	240V	220V	<b>230V</b>	240V	220V	<b>230V</b>	240V	
YY		<b>200V</b>			<b>200V</b>			<b>200V</b>			<b>200V</b>		
<b>12 wires version</b>													
LSA 47.2 VS2	kVA	365	<b>365</b>	365	330	<b>330</b>	330	405	<b>405</b>	405	420	<b>420</b>	420
	kW	292	<b>292</b>	292	264	<b>264</b>	264	324	<b>324</b>	324	336	<b>336</b>	336
LSA 47.2 S4	kVA	410	<b>410</b>	410	370	<b>370</b>	370	430	<b>430</b>	430	450	<b>450</b>	450
	kW	328	<b>328</b>	328	296	<b>296</b>	296	344	<b>344</b>	344	360	<b>360</b>	360
LSA 47.2 S5	kVA	455	<b>455</b>	455	405	<b>405</b>	405	471	<b>471</b>	471	500	<b>500</b>	500
	kW	364	<b>364</b>	364	324	<b>324</b>	324	377	<b>377</b>	377	400	<b>400</b>	400
LSA 47.2 M7	kVA	500	<b>500</b>	500	465	<b>465</b>	465	550	<b>550</b>	550	570	<b>570</b>	570
	kW	400	<b>400</b>	400	372	<b>372</b>	372	440	<b>440</b>	440	456	<b>456</b>	456
LSA 47.2 M8	kVA	550	<b>550</b>	550	500	<b>500</b>	500	575	<b>575</b>	575	600	<b>600</b>	600
	kW	440	<b>440</b>	440	400	<b>400</b>	400	460	<b>460</b>	460	480	<b>480</b>	480
LSA 47.2 L9	kVA	600	<b>600</b>	600	535	<b>535</b>	535	630	<b>630</b>	630	660	<b>660</b>	660
	kW	480	<b>480</b>	480	428	<b>428</b>	428	504	<b>504</b>	504	528	<b>528</b>	528
<b>6 wires version</b>													
Y	380V	<b>400V</b>	415V	380V	<b>400V</b>	415V	380V	<b>400V</b>	415V	380V	<b>400V</b>	415V	
Δ	220V	<b>230V</b>	240V	220V	<b>230V</b>	240V	220V	<b>230V</b>	240V	220V	<b>230V</b>	240V	
LSA 47.2 L9*	kVA	600	<b>600</b>	600	535	<b>535</b>	535	630	<b>630</b>	630	660	<b>660</b>	660
	kW	480	<b>480</b>	480	428	<b>428</b>	428	504	<b>504</b>	504	528	<b>528</b>	528

## Ratings 60 Hz - 1800 R.P.M.

kVA / kW - P.F. = 0.8																	
Duty/T°C	Continuous duty/40°C				Continuous duty/40°C				Stand-by/40°C				Stand-by/27°C				
Class/T°K	H/125°K				F/105°K				H/150°K				H/163°K				
Phase	3 ph.				3 ph.				3 ph.				3 ph.				
Y	380V	416V	440V	<b>480V</b>	380V	416V	440V	<b>480V</b>	380V	416V	440V	<b>480V</b>	380V	416V	440V	<b>480V</b>	
Δ	220V	240V			220V	240V			220V	240V			220V	240V			
YY		208V	220V	<b>240V</b>		208V	220V	<b>240V</b>		208V	220V	<b>240V</b>		208V	220V	<b>240V</b>	
<b>12 wires version</b>																	
LSA 47.2 VS2	kVA	424	454	456	<b>456</b>	394	410	410	<b>410</b>	451	483	500	<b>511</b>	469	500	518	<b>530</b>
	kW	339	363	365	<b>365</b>	315	328	328	<b>328</b>	361	386	400	<b>409</b>	375	400	414	<b>424</b>
LSA 47.2 S4	kVA	450	480	500	<b>512</b>	396	442	442	<b>465</b>	475	513	533	<b>550</b>	500	530	550	<b>581</b>
	kW	360	384	400	<b>410</b>	317	354	354	<b>372</b>	380	410	426	<b>440</b>	400	424	440	<b>465</b>
LSA 47.2 S5	kVA	475	510	531	<b>570</b>	441	473	493	<b>518</b>	503	543	566	<b>592</b>	527	562	585	<b>625</b>
	kW	380	408	425	<b>456</b>	353	378	394	<b>414</b>	402	434	453	<b>474</b>	422	450	468	<b>500</b>
LSA 47.2 M7	kVA	562	610	625	<b>625</b>	523	566	581	<b>590</b>	600	651	669	<b>680</b>	625	668	690	<b>700</b>
	kW	450	488	500	<b>500</b>	418	453	465	<b>472</b>	480	521	535	<b>554</b>	500	534	552	<b>560</b>
LSA 47.2 M8	kVA	562	610	630	<b>690</b>	523	566	587	<b>632</b>	600	651	672	<b>729</b>	625	671	705	<b>750</b>
	kW	450	488	504	<b>552</b>	418	453	470	<b>506</b>	480	521	538	<b>583</b>	500	537	564	<b>600</b>
LSA 47.2 L9	kVA	602	661	685	<b>750</b>	556	609	634	<b>675</b>	643	707	734	<b>780</b>	667	728	763	<b>825</b>
	kW	482	529	548	<b>600</b>	445	487	507	<b>540</b>	514	566	587	<b>624</b>	534	582	610	<b>660</b>
<b>6 wires version</b>																	
Y	380V	416V	440V	<b>480V</b>	380V	416V	440V	<b>480V</b>	380V	416V	440V	<b>480V</b>	380V	416V	440V	<b>480V</b>	
Δ	220V	240V			220V	240V			220V	240V			220V	240V			
LSA 47.2 L9*	kVA	602	661	685	<b>750</b>	556	609	634	<b>675</b>	643	707	734	<b>780</b>	667	728	763	<b>825</b>
	kW	482	529	548	<b>600</b>	445	487	507	<b>540</b>	514	566	587	<b>624</b>	534	582	610	<b>660</b>

\* AREP excitation only

**Efficiencies 400 V - 50 Hz (P.F.: 1) (P.F.: 0.8)**

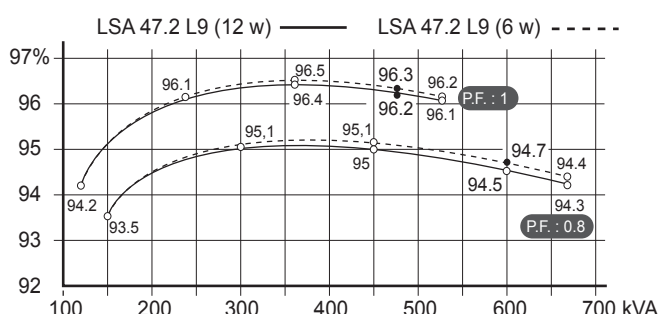
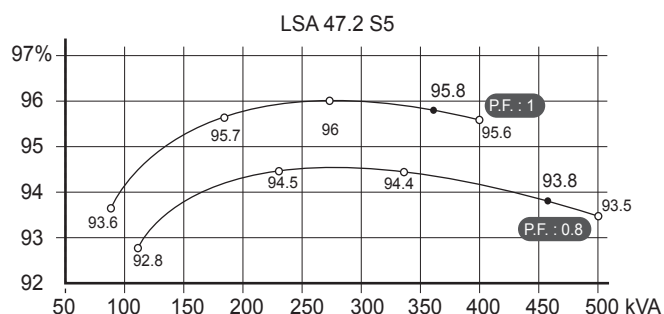
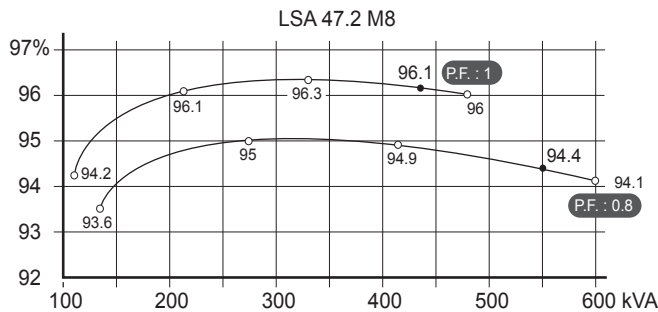
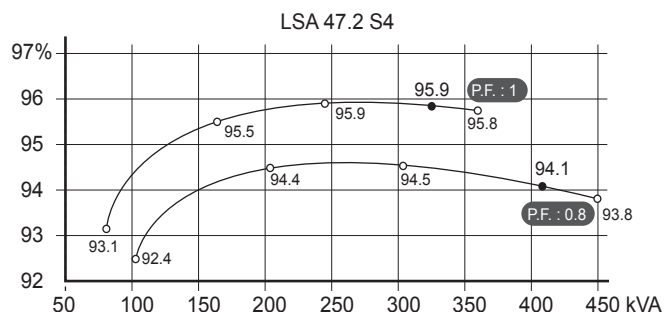
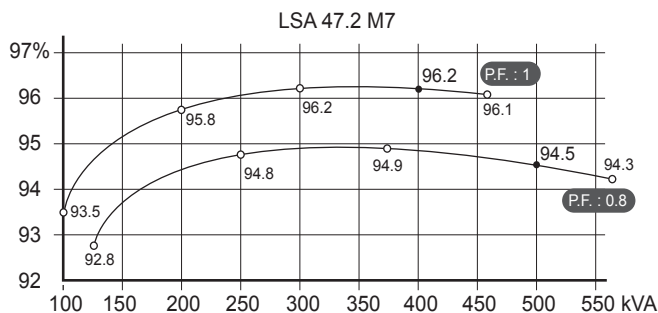
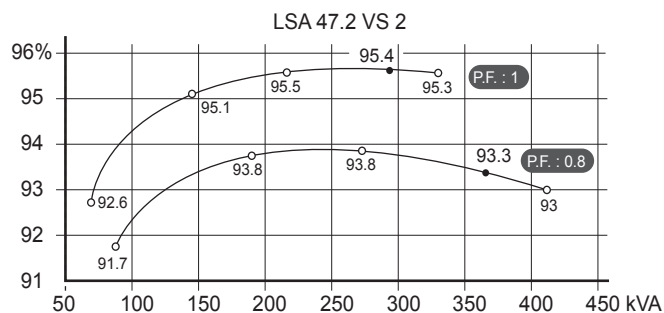

**Reactances (%). Time constants (ms) - Class H / 400 V**

	VS2 (12w)	S4 (12w)	S5 (12w)	M7 (12w)	M8 (12w)	L9 (12w)	L9 (6w)
<b>Kcc</b> Short-circuit ratio	0.38	0.37	0.33	0.41	0.32	0.37	0.38
<b>Xd</b> Direct-axis synchronous reactance unsaturated	336	322	357	307	360	330	325
<b>Xq</b> Quadrature-axis synchronous reactance unsaturated	201	193	214	184	216	198	195
<b>T'do</b> No-load transient time constant	1738	1855	1855	1930	1958	1997	1997
<b>X'd</b> Direct-axis transient reactance saturated	19.3	17.3	19.2	15.9	18.3	16.5	16.2
<b>T'd</b> Short-circuit transient time constant	100	100	100	100	100	100	100
<b>X''d</b> Direct-axis subtransient reactance saturated	13.5	12.1	13.5	11.1	12.9	11.4	11.6
<b>T''d</b> Subtransient time constant	10	10	10	10	10	10	10
<b>X''q</b> Quadrature-axis subtransient reactance saturated	18.4	16.3	18	14.7	17	15	15.2
<b>Xo</b> Zero sequence reactance	0.9	0.9	0.9	0.7	0.6	0.9	0.2
<b>X2</b> Negative sequence reactance saturated	16	14.2	15.8	13	15	13.2	13.4
<b>Ta</b> Armature time constant	15	15	15	15	15	15	15

**Other class H/400 V data**

<b>io (A)</b> No-load excitation current	1	0.9	0.9	1	0.9	0.9	0.9
<b>ic (A)</b> On-load excitation current	3.8	3.5	3.8	3.6	3.7	3.7	3.7
<b>uc (V)</b> On-load excitation voltage	39	35	38	36	37	36	36
<b>ms</b> Response time ( $\Delta U = 20\%$ transient)	500	500	500	500	500	500	500
<b>kVA</b> Start ( $\Delta U = 20\%$ cont. or 30% trans.) SHUNT	722	928	928	1073	1159	1258	1258
<b>kVA</b> Start ( $\Delta U = 20\%$ cont. or 30% trans.) AREP	805	1035	1035	1195	1294	1400	1400
<b>%</b> Transient $\Delta U$ (on-load 4/4) SHUNT - P.F.: 0.8 <sub>LAG</sub>	16.8	15.5	16.7	14.6	16.2	15	14.8
<b>%</b> Transient $\Delta U$ (on-load 4/4) AREP - P.F.: 0.8 <sub>LAG</sub>	13.7	12.7	13.6	11.9	13.2	12.2	12.1
<b>W</b> No-load losses	5440	5690	5690	6540	6120	6780	6880
<b>W</b> Heat dissipation	20780	20470	23780	23040	26020	27490	26720

**Transient voltage variation 400V - 50 Hz**

Load application (SHUNT excitation)

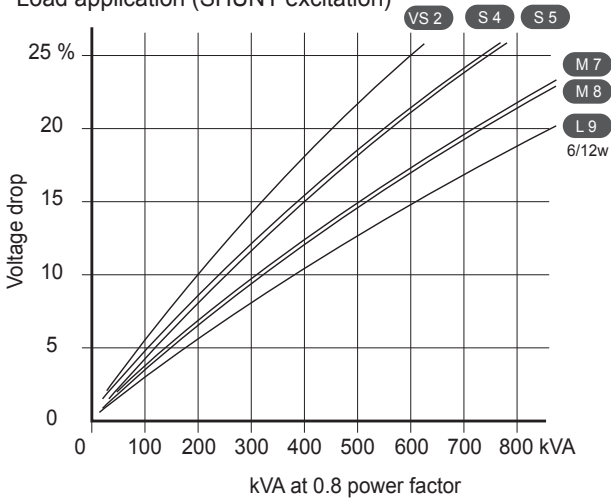

Load application (AREP or PMG excitation)

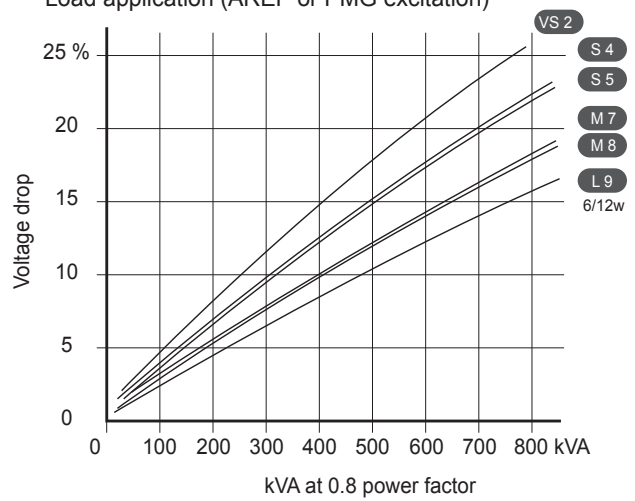

Load rejection (SHUNT excitation)

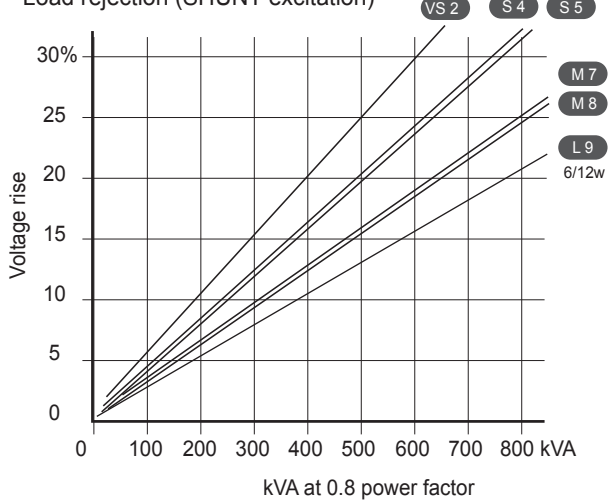

Load rejection (AREP or PMG excitation)

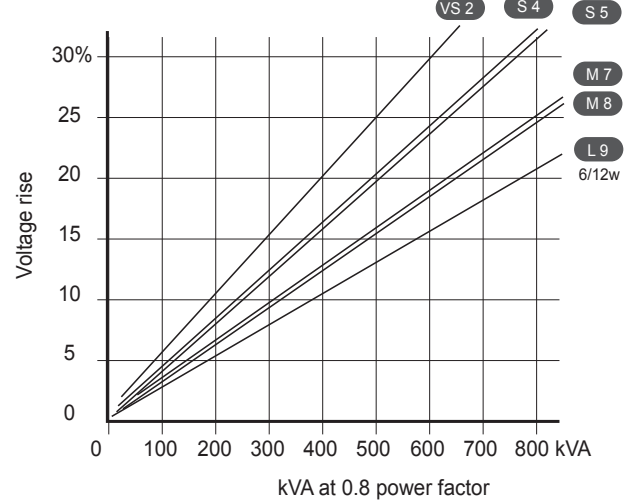

Motor starting (SHUNT excitation)

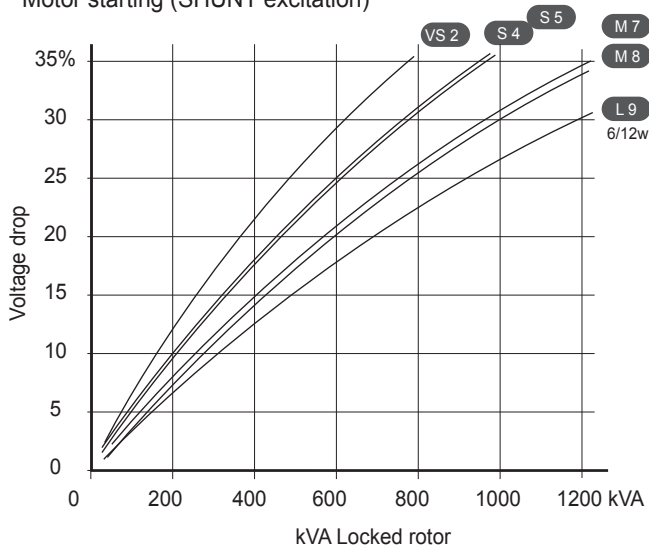

Motor starting (AREP or PMG excitation)

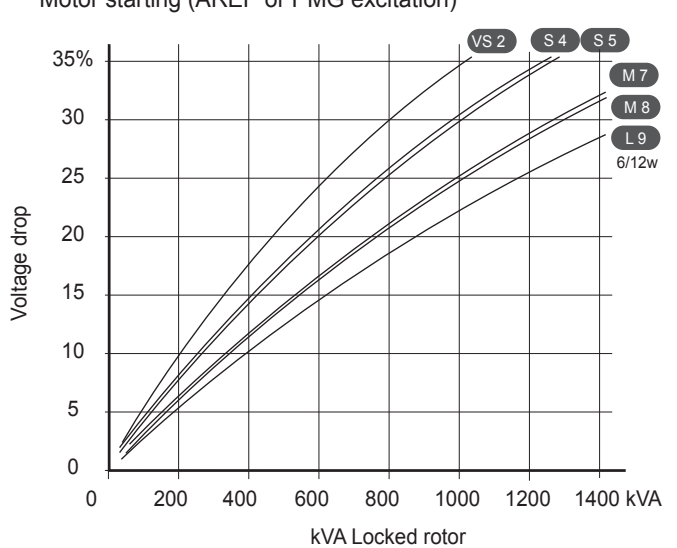

- 1) For a starting P.F. other than 0.6, the starting kVA must be multiplied by  $K = \text{Sine P.F.} / 0.8$
- 2) For voltages other than 400V (Y), 230V (Δ) at 50 Hz, then kVA must be multiplied by  $(400/U)^2$  or  $(230/U)^2$ .

**Efficiencies 480 V - 60 Hz (P.F.: 1) (P.F.: 0.8)**

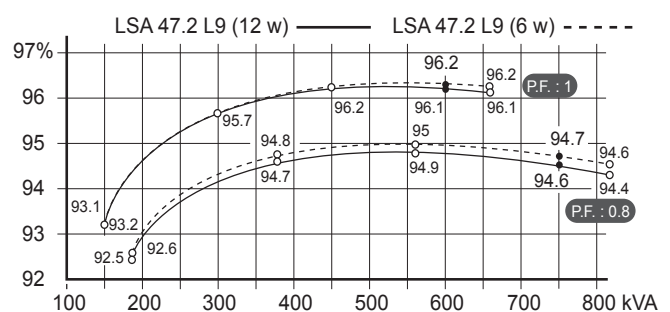
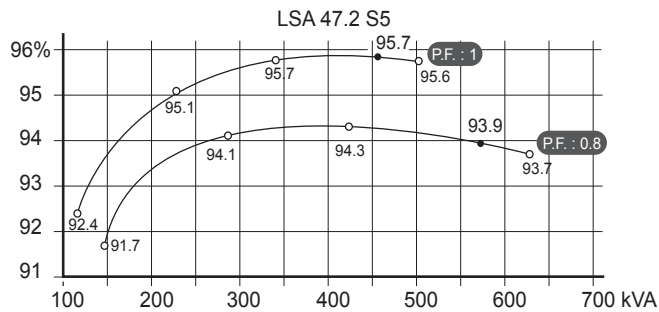
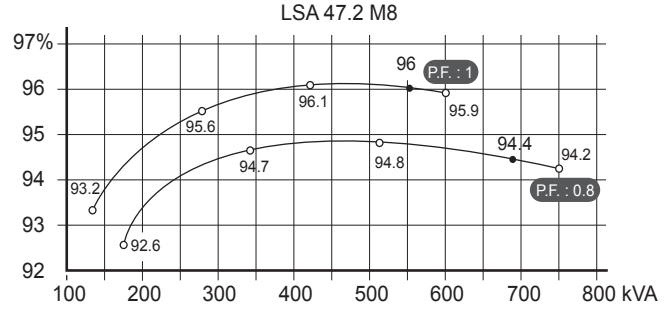
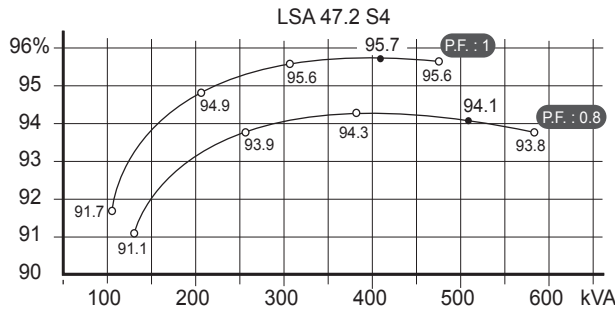
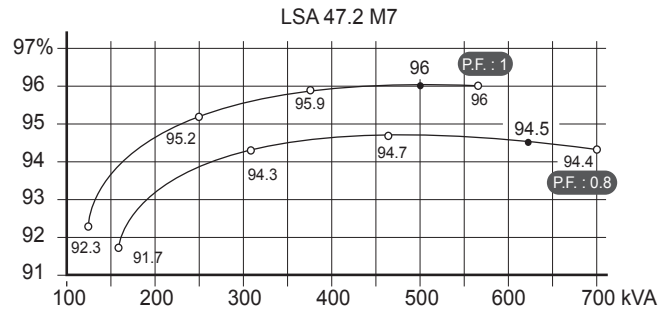
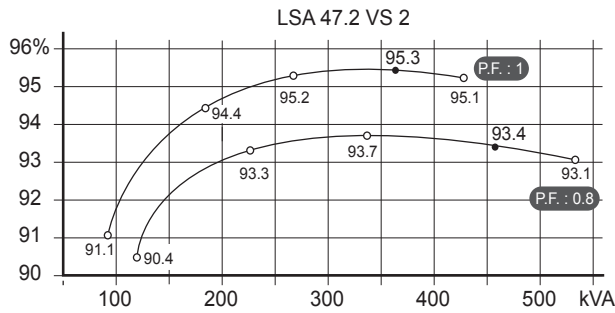

**Reactances (%). Time constants (ms) - Class H / 480 V**

	VS2 (12w)	S4 (12w)	S5 (12w)	M7 (12w)	M8 (12w)	L9 (12w)	L9 (6w)
<b>Kcc</b> Short-circuit ratio	0.36	0.36	0.32	0.40	0.31	0.35	0.36
<b>Xd</b> Direct-axis synchronous reactance unsaturated	349	335	373	319	376	344	338
<b>Xq</b> Quadrature-axis synchronous reactance unsaturated	209	201	223	191	225	206	203
<b>T'do</b> No-load transient time constant	1738	1855	1855	1930	1958	1997	1997
<b>X'd</b> Direct-axis transient reactance saturated	20.1	18	20.1	16.5	19.2	17.2	16.9
<b>T'd</b> Short-circuit transient time constant	100	100	100	100	100	100	100
<b>X''d</b> Direct-axis subtransient reactance saturated	14.1	12.6	14	11.6	13.4	11.8	12.1
<b>T''d</b> Subtransient time constant	10	10	10	10	10	10	10
<b>X''q</b> Quadrature-axis subtransient reactance saturated	19.1	16.9	18.8	15.3	17.8	15.6	15.8
<b>Xo</b> Zero sequence reactance	0.1	0.4	0.1	0.1	0.9	0.9	0.4
<b>X2</b> Negative sequence reactance saturated	16.6	14.8	16.5	13.5	15.6	13.7	14
<b>Ta</b> Armature time constant	15	15	15	15	15	15	15

**Other class H/480 V data**

<b>io (A)</b> No-load excitation current	1	0.9	0.9	1	0.9	0.9	0.9
<b>ic (A)</b> On-load excitation current	3.9	3.5	3.9	3.7	3.8	3.7	3.7
<b>uc (V)</b> On-load excitation voltage	40	35	39	37	38	37	37
<b>ms</b> Response time ( $\Delta U = 20\%$ transient)	500	500	500	500	500	500	500
<b>kVA</b> Start ( $\Delta U = 20\%$ cont. or 30% trans.) SHUNT	890	1136	1136	1318	1433	1550	1554
<b>kVA</b> Start ( $\Delta U = 20\%$ cont. or 30% trans.) AREP	994	1271	1271	1473	1606	1733	1737
<b>%</b> Transient $\Delta U$ (on-load 4/4) SHUNT - P.F.: 0.8 <sub>LAG</sub>	17.3	16	17.3	15	16.7	15.5	15.3
<b>%</b> Transient $\Delta U$ (on-load 4/4) AREP - P.F.: 0.8 <sub>LAG</sub>	14.1	13	14.1	12.2	13.6	12.6	12.4
<b>W</b> No-load losses	8540	8910	8910	10080	9530	10440	10580
<b>W</b> Heat dissipation	25650	25650	29340	28630	32190	33870	33010

**Transient voltage variation 480V - 60 Hz**

Load application (SHUNT excitation)

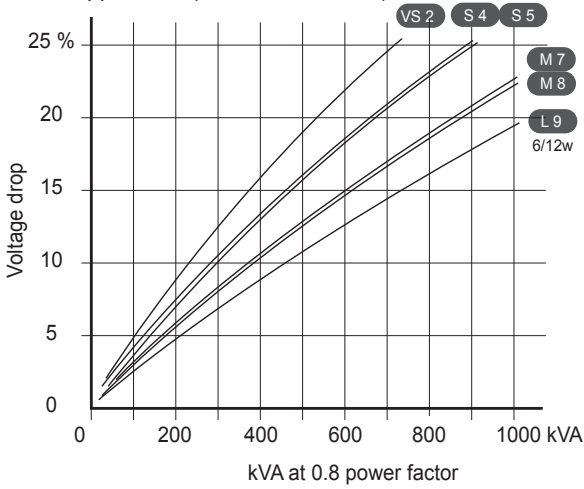

Load application (AREP or PMG excitation)

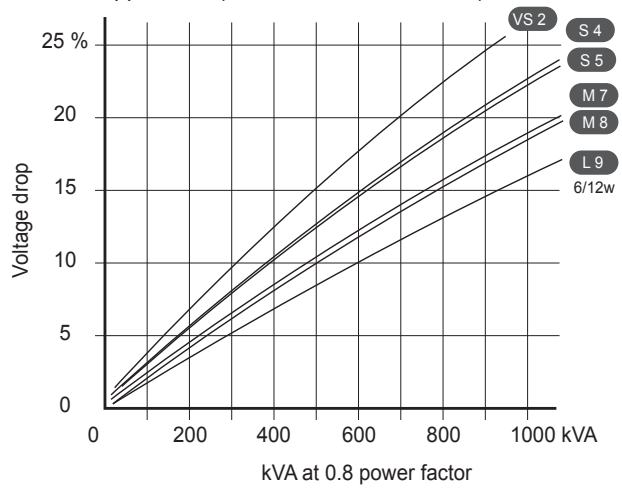

Load rejection (SHUNT excitation)

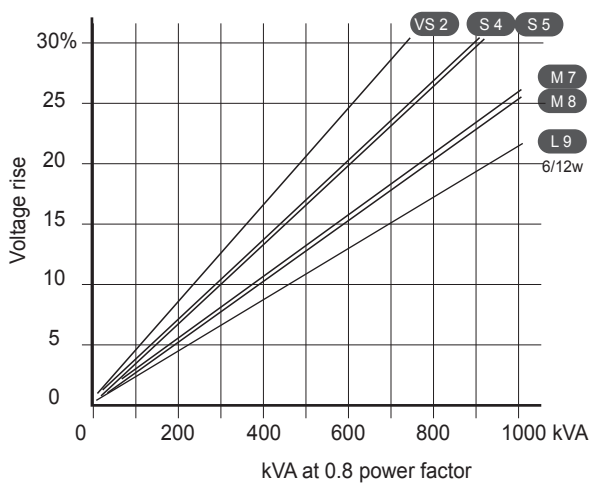

Load rejection (AREP or PMG excitation)

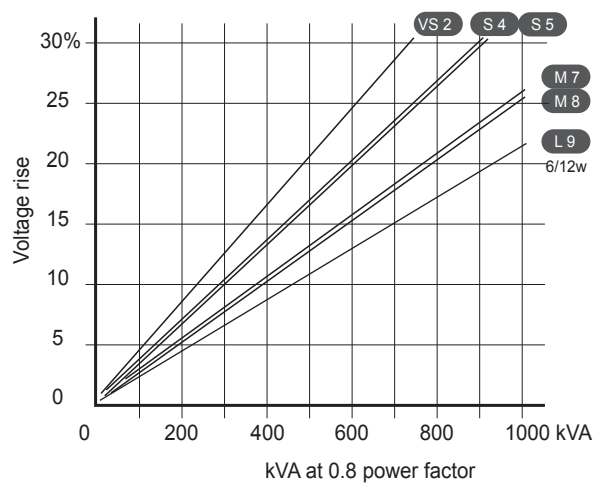

Motor starting (SHUNT excitation)

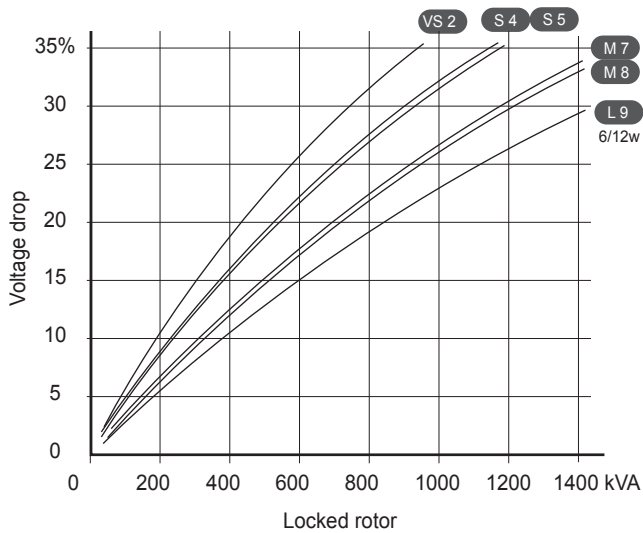

Motor starting (AREP or PMG excitation)

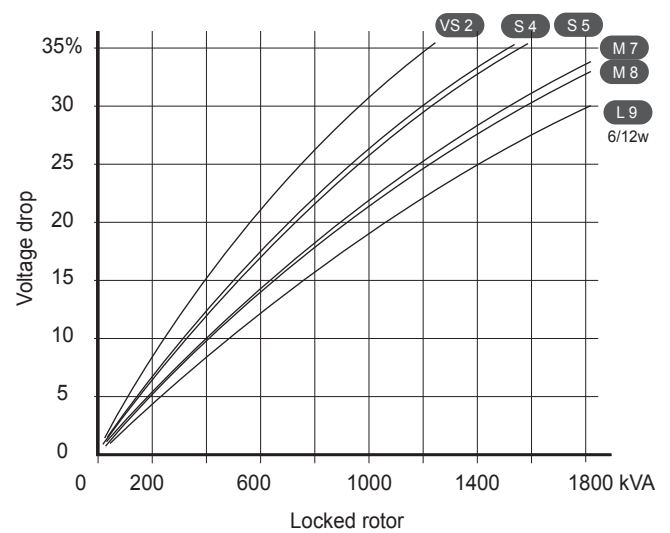

- 1) For a starting P.F. other than 0.6, the starting kVA must be multiplied by  $K = \text{Sine P.F.} / 0.8$
- 2) For voltages other than 480V (Y), 277V ( $\Delta$ ), 240V (YY) at 60 Hz, then kVA must be multiplied by  $(480/U)^2$  or  $(277/U)^2$  or  $(240/U)^2$ .

3-phase short-circuit curves at no load and rated speed (star connection Y)

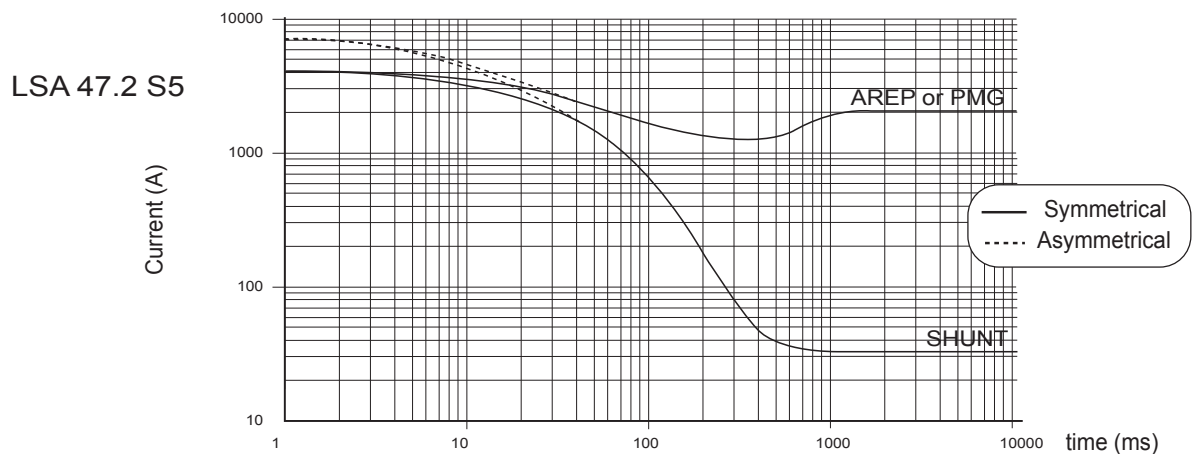
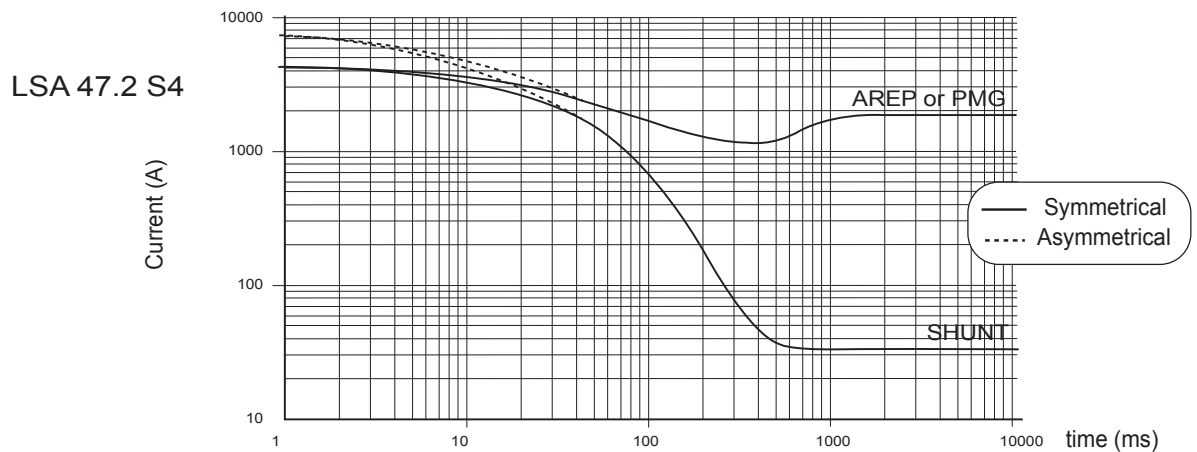
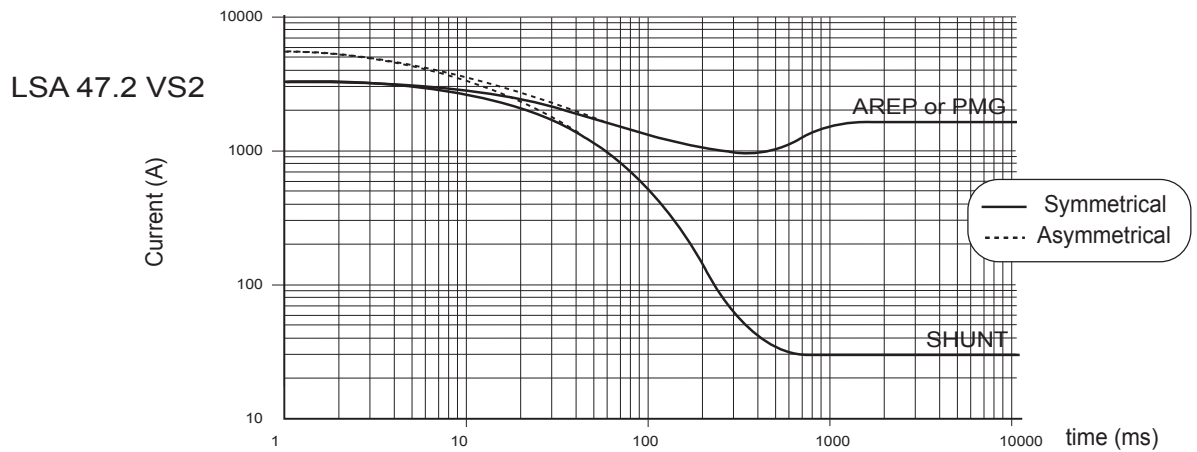

**Influence due to connection**

Curves shown are for star (Y) connection.

For other connections, use the following multiplication factors:

- Series delta : current value x 1.732 - Parallel star : current value x 2



3-phase short-circuit curves at no load and rated speed (star connection Y)

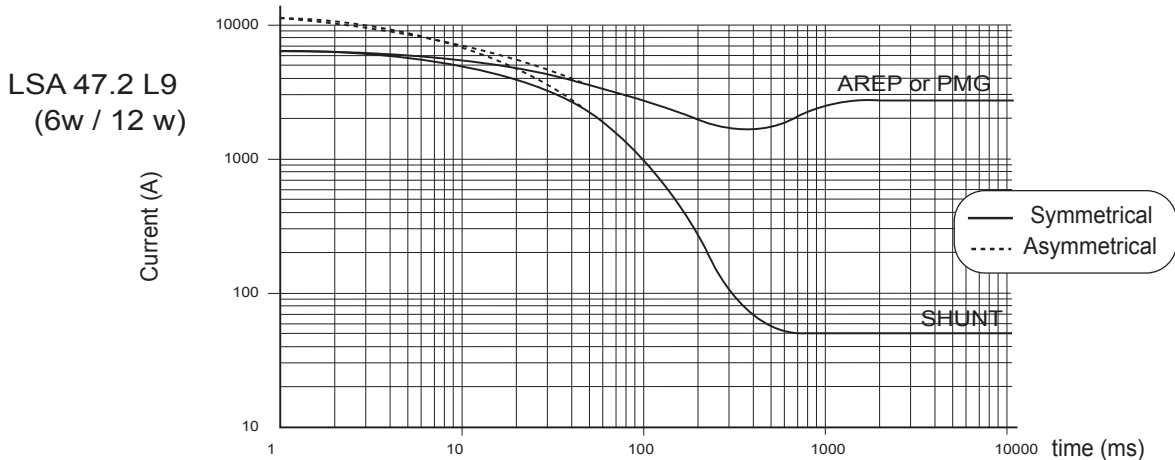
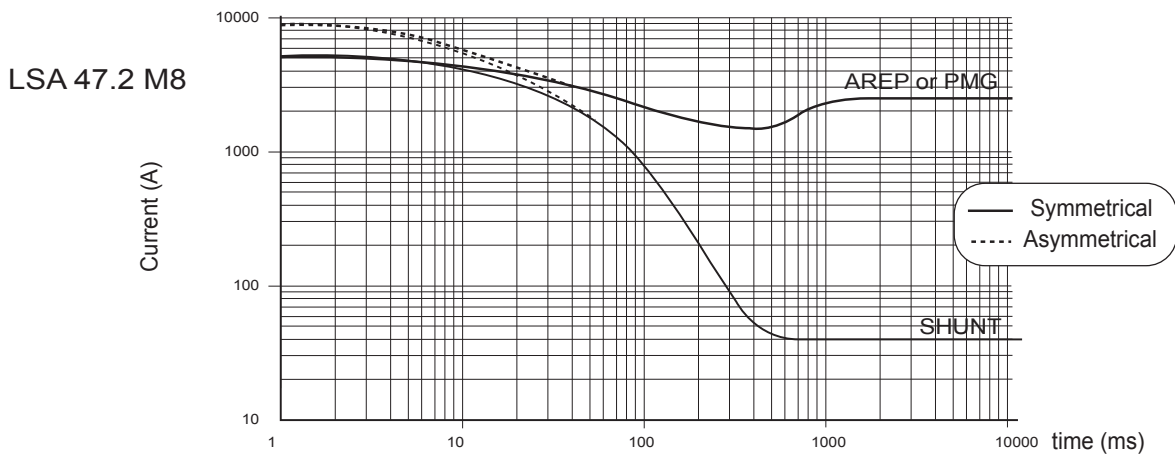
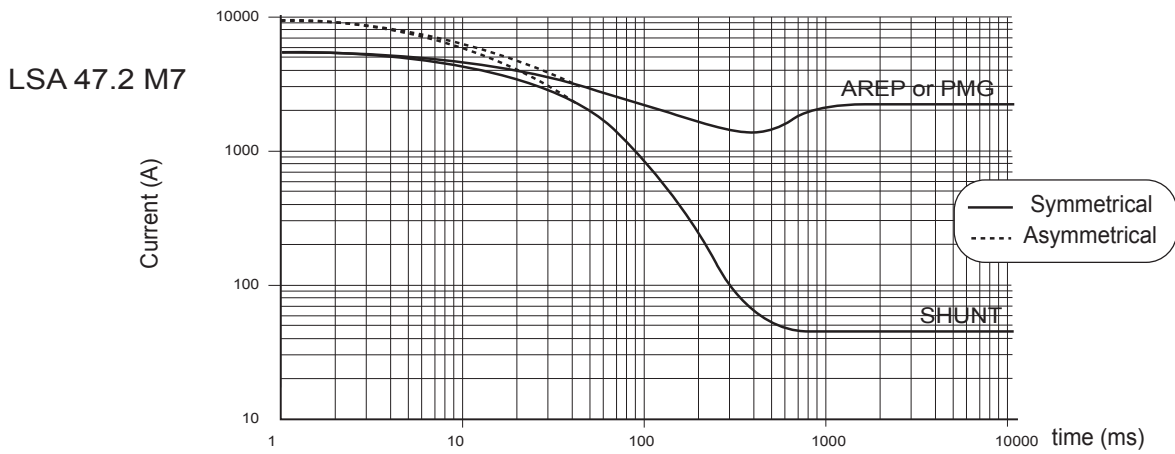

**Influence due to short-circuit**

Curves are based on a three-phase short-circuit.  
For other types of short-circuit, use the following multiplication factors.

	3-phase	2-phase L/L	1-phase L/N
Instantaneous (max.)	1	0.87	1.3
Continuous	1	1.5	2.2
Maximum duration (AREP/PMG)	10 sec.	5 sec.	2 sec.

Single-bearing dimensions

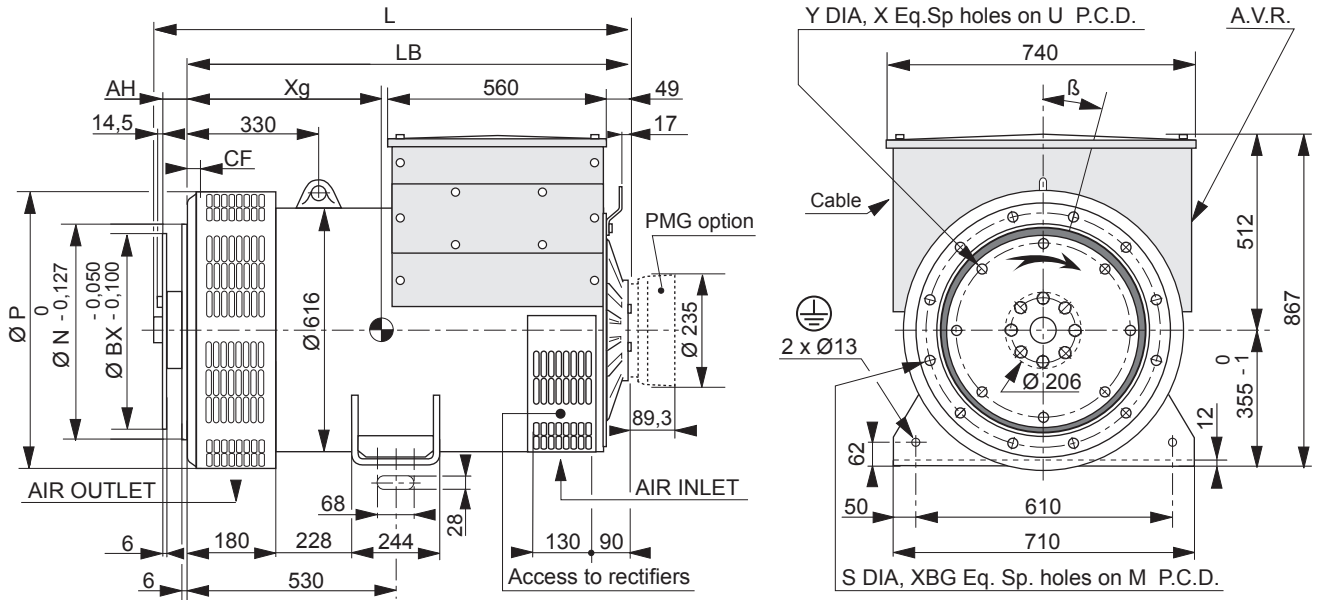

Dimensions (mm) and weight				
Type	L without PMG maxi*	LB	Xg	Weight (kg)
LSA 47.2 VS2	1055	996	437	976
LSA 47.2 S4	1115	1056	471	1113
LSA 47.2 S5	1115	1056	471	1113
LSA 47.2 M7	1215	1156	511	1240
LSA 47.2 M8	1215	1156	520	1289
LSA 47.2 L9	1235	1176	545	1372

\* L maxi = LB + AH maxi + 19

Coupling			
Flex plate	11 ½	14	18
Flange S.A.E 1	X	X	
Flange S.A.E ½		X	
Flange S.A.E 0		X	X

Flange (mm)							
S.A.E.	P	N	M	XBG	S	β°	CF
1	713	511.175	530.225	12	12	15°	15
½	713	584.2	619.125	12	14	15°	22
0	713	647.7	679.45	16	14	11° 15'	42

Flex plate (mm)					
S.A.E.	BX	U	X	Y	AH
11 ½	352.42	333.38	8	11	39.6
14	466.72	438.15	8	14	25.4
18	571.5	542.92	6	17	15.7

Torsional analysis data

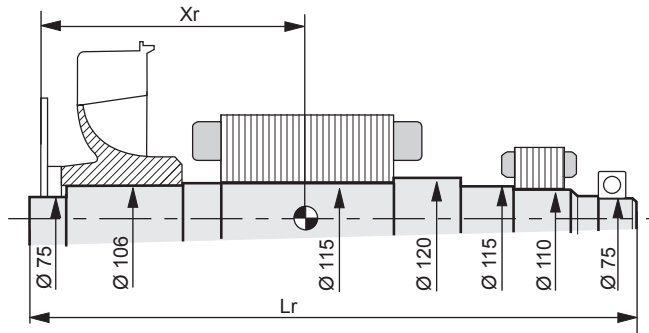

Centre of gravity: Xr (mm), Rotor length: Lr (mm), Weight: M (kg), Moment of inertia: J (kgm²): (4J = MD²)												
Flex plate	S.A.E. 11 ½				S.A.E. 14				S.A.E. 18			
	Xr	Lr	M	J	Xr	Lr	M	J	Xr	Lr	M	J
LSA 47.2 VS2	432.5	1029	387	5.99	418.3	1029	387	6.12	408.5	1029	387	6.38
LSA 47.2 S4	470	1089	442	6.90	456	1089	442	7.03	446	1089	442	7.29
LSA 47.2 S5	470	1089	442	6.90	456	1089	442	7.03	446	1089	442	7.29
LSA 47.2 M7	510	1189	495	7.61	496	1189	495	7.74	486	1189	495	8
LSA 47.2 M8	521	1189	514	8.01	507	1189	514	8.14	497	1189	514	8.40
LSA 47.2 L9	542	1209	547	8.52	528	1209	547	8.65	518	1209	547	8.91

NOTE : Dimensions are for information only and may be subject to modifications. Contractual 2D drawings can be downloaded from the Leroy-Somer site, 3D drawing files are available upon request. The torsional analysis of the transmission is imperative. All values are available upon request.

Two-bearing dimensions

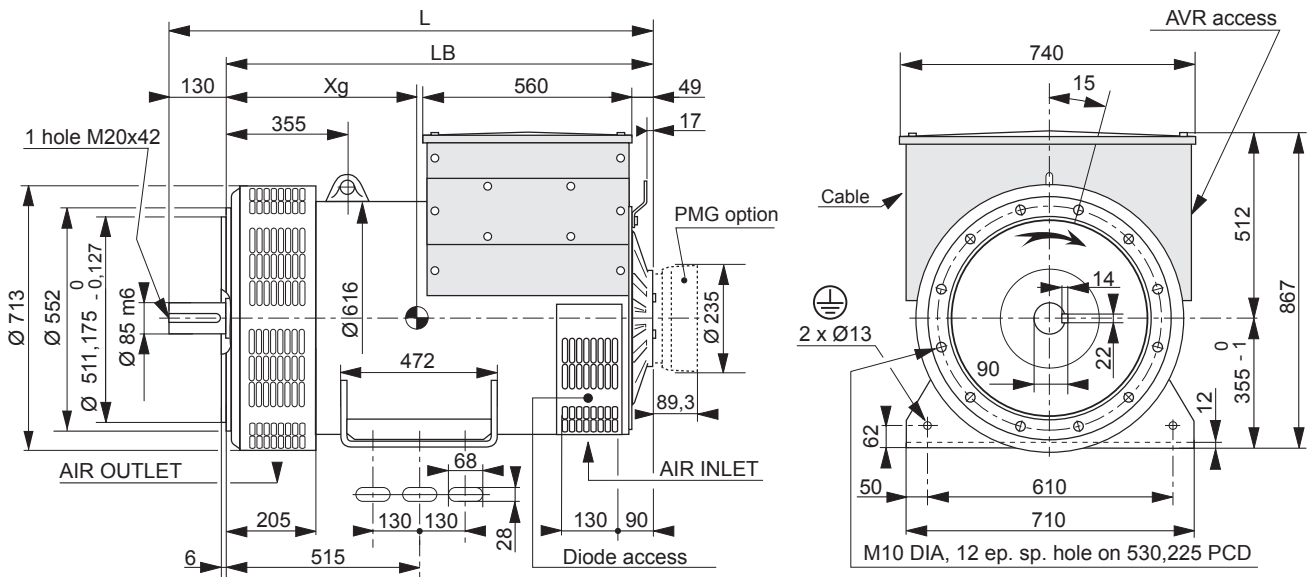

Dimensions (mm) and weight				
Type	L without PMG	LB	Xg	Weight (kg)
LSA 47.2 VS2	1151	1021	457	996
LSA 47.2 S4	1211	1081	491	1126
LSA 47.2 S5	1211	1081	491	1126
LSA 47.2 M7	1311	1181	531	1253
LSA 47.2 M8	1311	1181	531	1302
LSA 47.2 L9	1331	1201	565	1392

Torsional analysis data

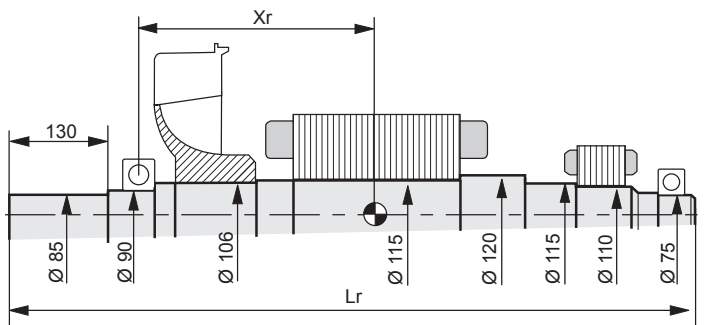

Centre of gravity: Xr (mm), Rotor length: Lr (mm), Weight: M (kg), Moment of inertia: J (kgm <sup>2</sup> ): (4J = MD <sup>2</sup> )				
Type	Xr	Lr	M	J
LSA 47.2 VS2	396.4	1139	368.5	5.79
LSA 47.2 S4	433.2	1199	424	6.70
LSA 47.2 S5	433.2	1199	424	6.70
LSA 47.2 M7	473	1299	476.2	7.41
LSA 47.2 M8	483.5	1299	494.9	7.81
LSA 47.2 L9	504.5	1319	528	8.32

NOTE : Dimensions are for information only and may be subject to modifications. Contractual 2D drawings can be downloaded from the Leroy-Somer site, 3D drawing files are available upon request. The torsional analysis of the transmission is imperative. All values are available upon request.

**LEROY-SOMER**<sup>™</sup>

[www.leroy-somer.com/epg](http://www.leroy-somer.com/epg)

[Linkedin.com/company/leroy-somer](https://www.linkedin.com/company/leroy-somer)  
[Twitter.com/Leroy\\_Somer\\_en](https://twitter.com/Leroy_Somer_en)  
[Facebook.com/LeroySomer.Nidec.en](https://www.facebook.com/LeroySomer.Nidec.en)  
[YouTube.com/LeroySomerOfficiel](https://www.youtube.com/LeroySomerOfficiel)



***Nidec***  
**All for dreams**

© Nidec 2020. The information contained in this brochure is for guidance only and does not form part of any contract. The accuracy cannot be guaranteed as Nidec have an ongoing process of development and reserve the right to change the specification of their products without notice.

Moteurs Leroy-Somer SAS. Siège : Bd Marcellin Leroy, CS 10015, 16915 Angoulême Cedex 9, France.  
Capital social : 38 679 664 €, RCS Angoulême 338 567 258.